

THE GREAT BRITISH *Sewing Bee*

1930S Blouse pattern
Project design © Love Productions 2013
This design is protected by copyright
and must not be made for resale.

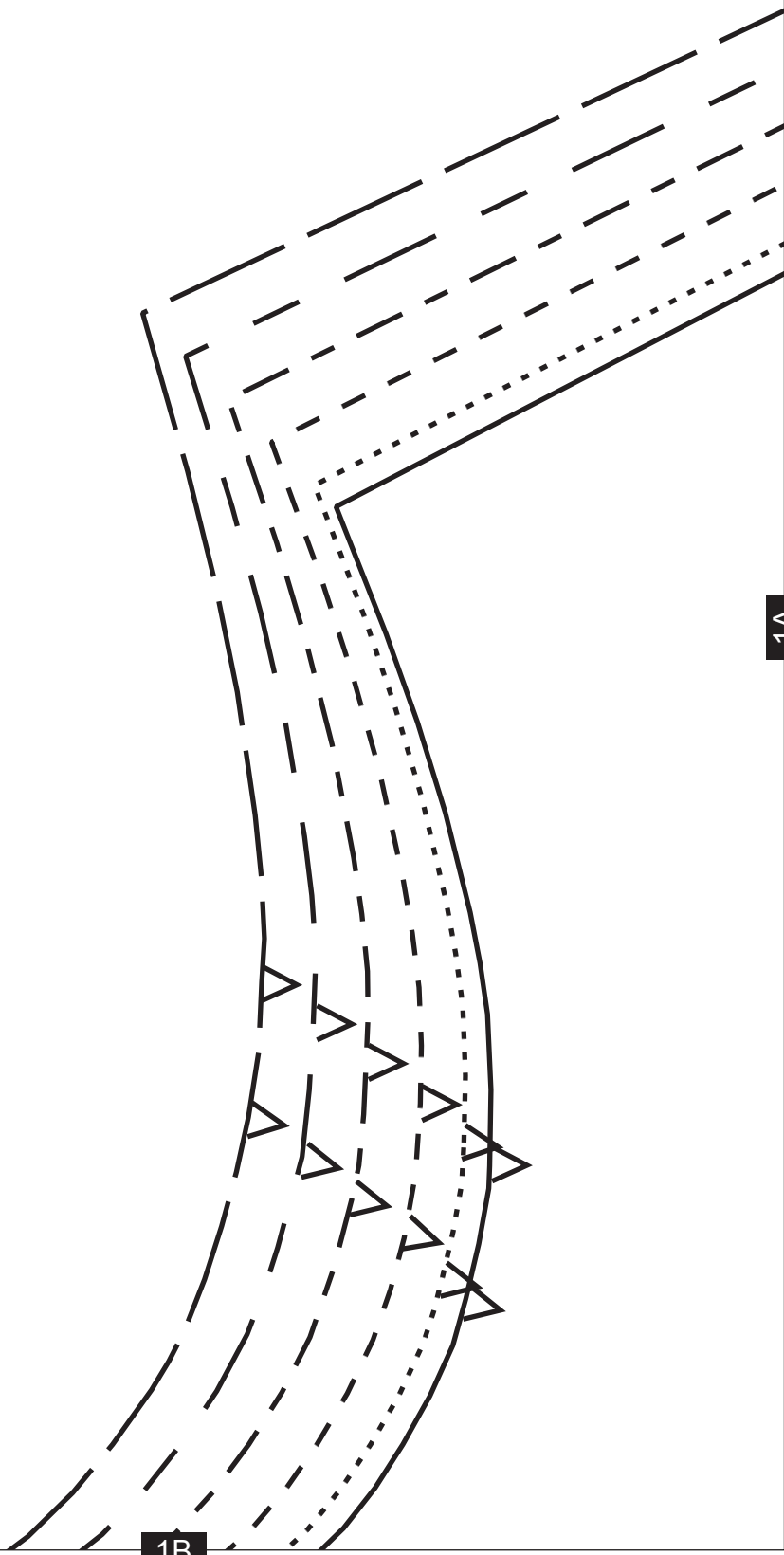
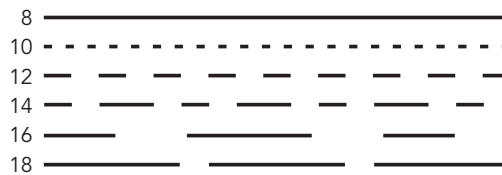

1A

1B

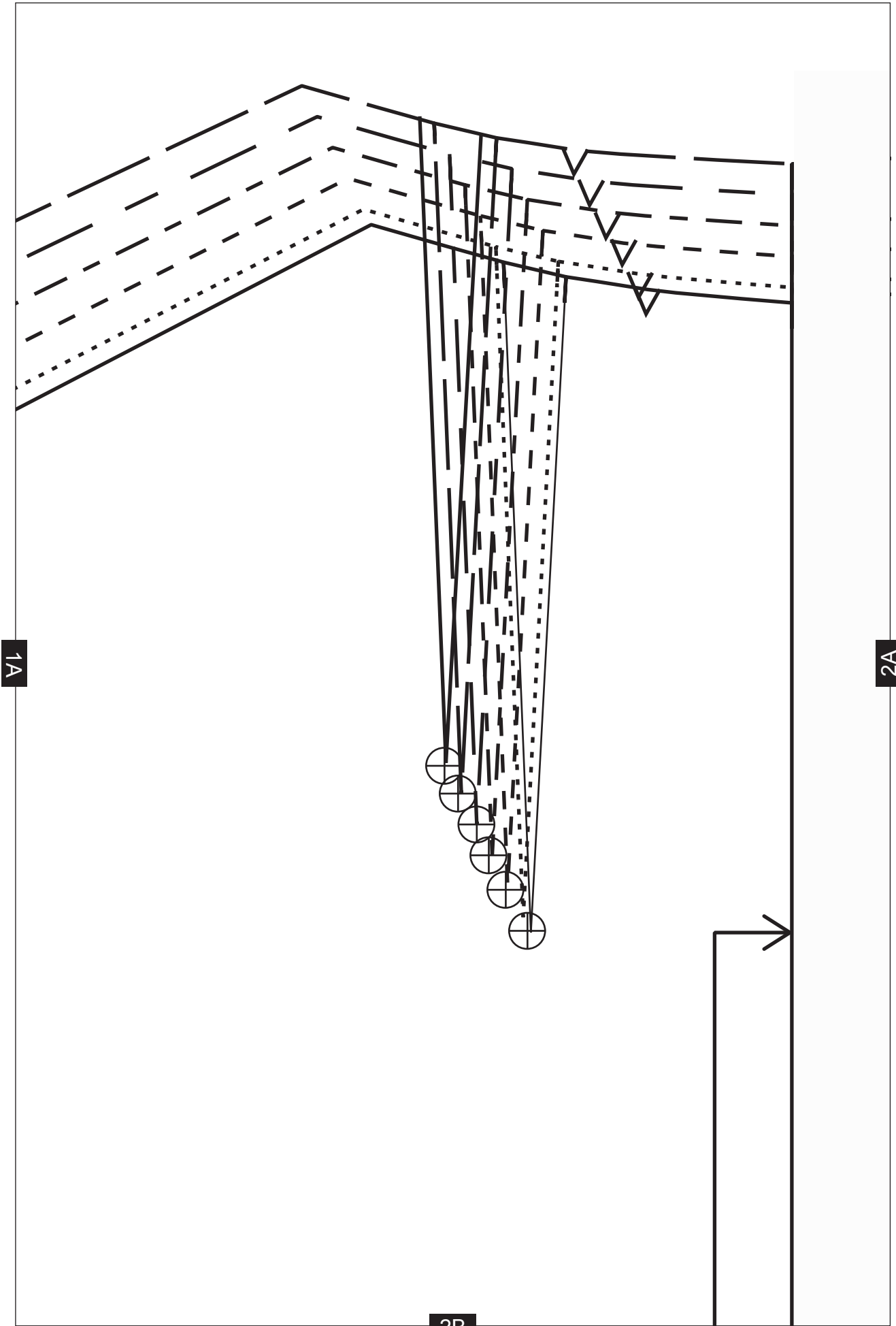

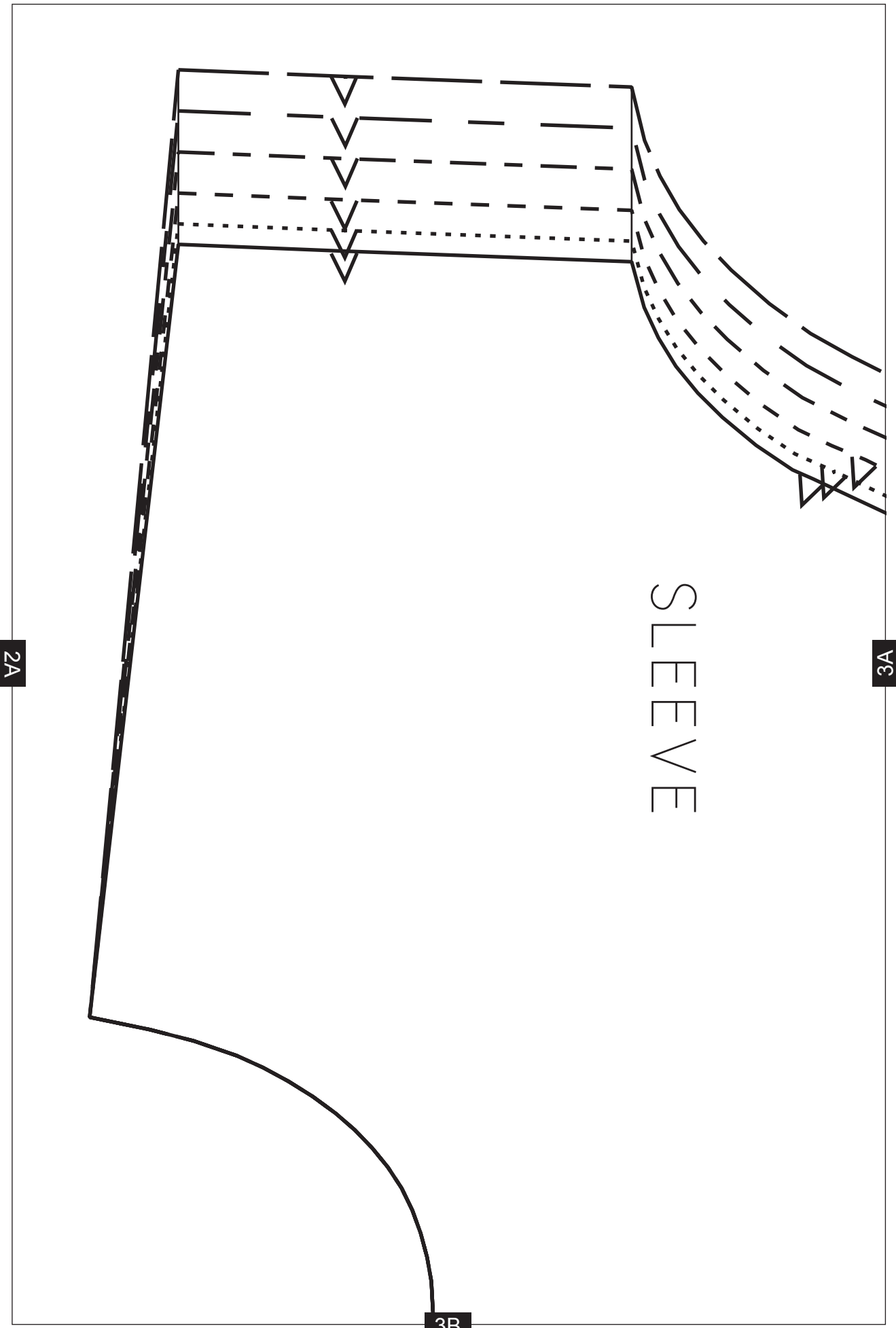

2A

3A

3B

SLEEVE

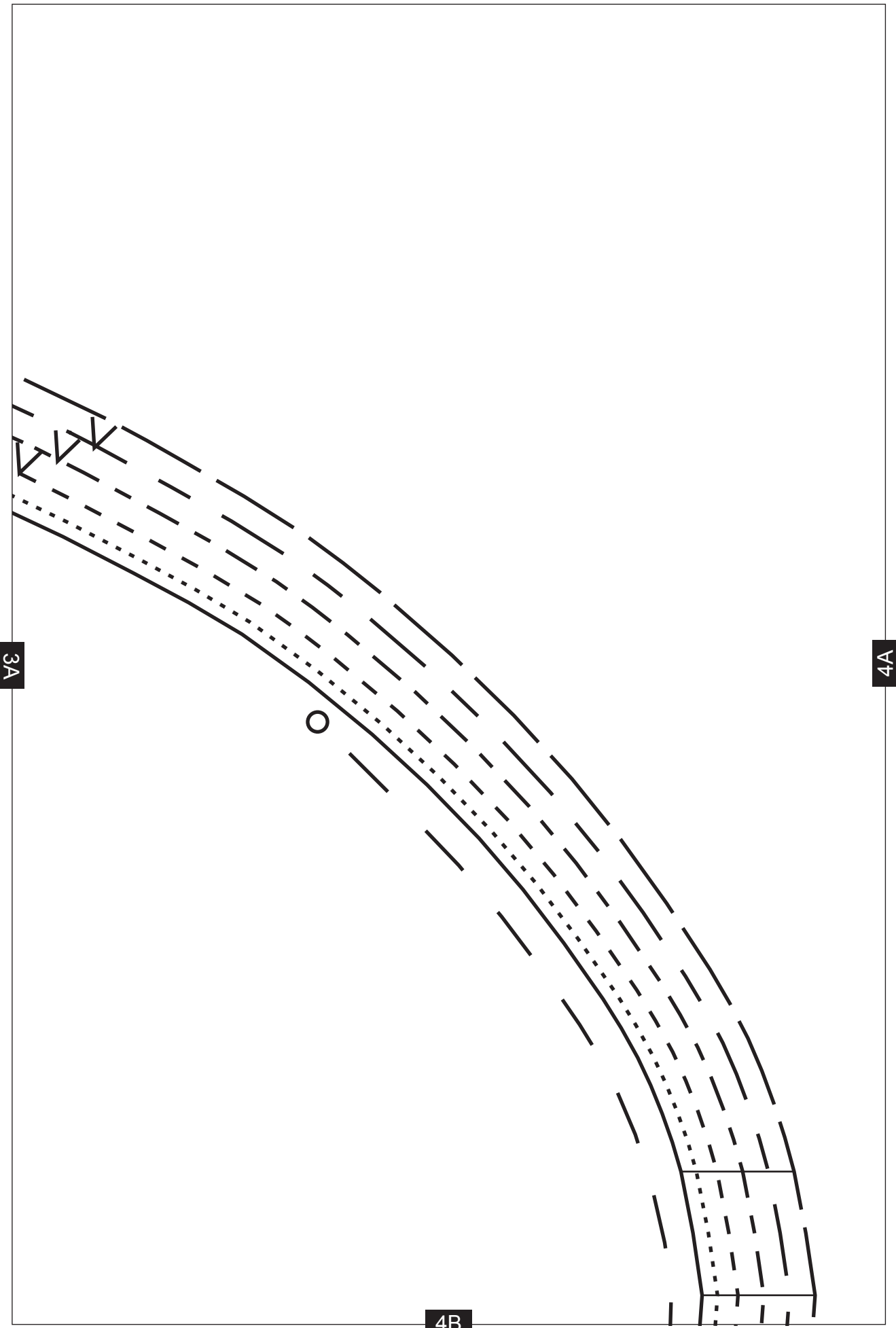

3A

4A

4B

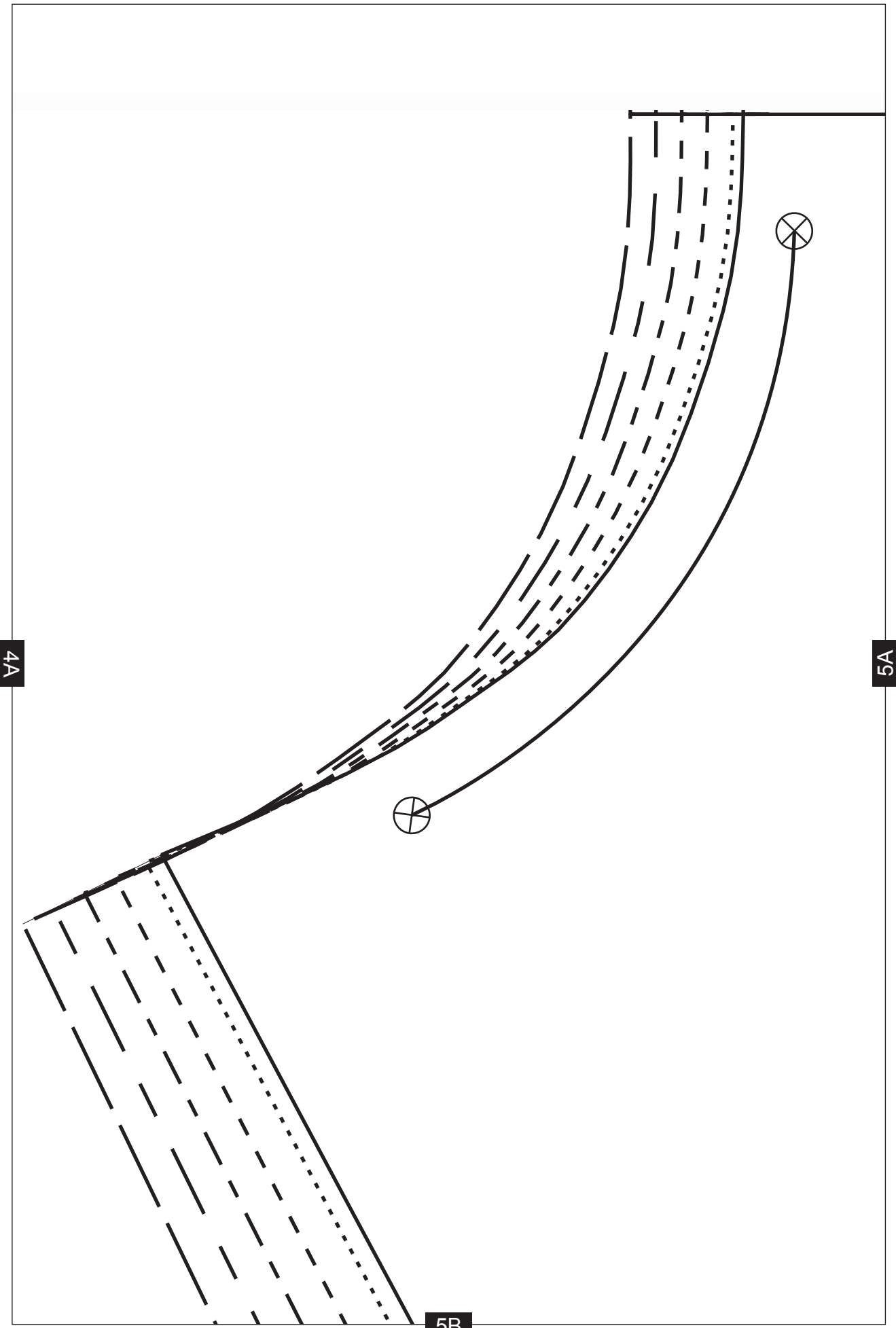

4A

5A

5B

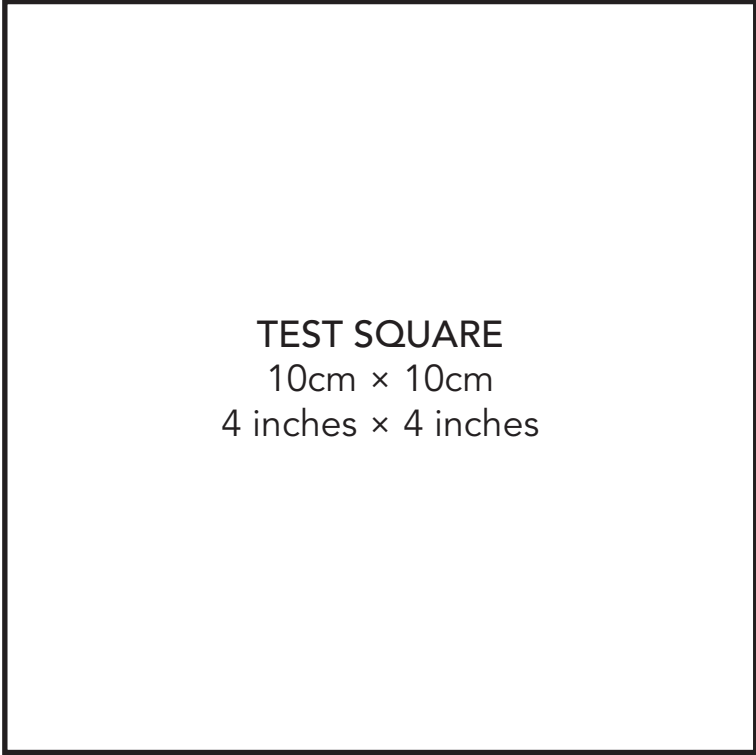

5A

6A



6B

6A

FRONT



7B

0



1B

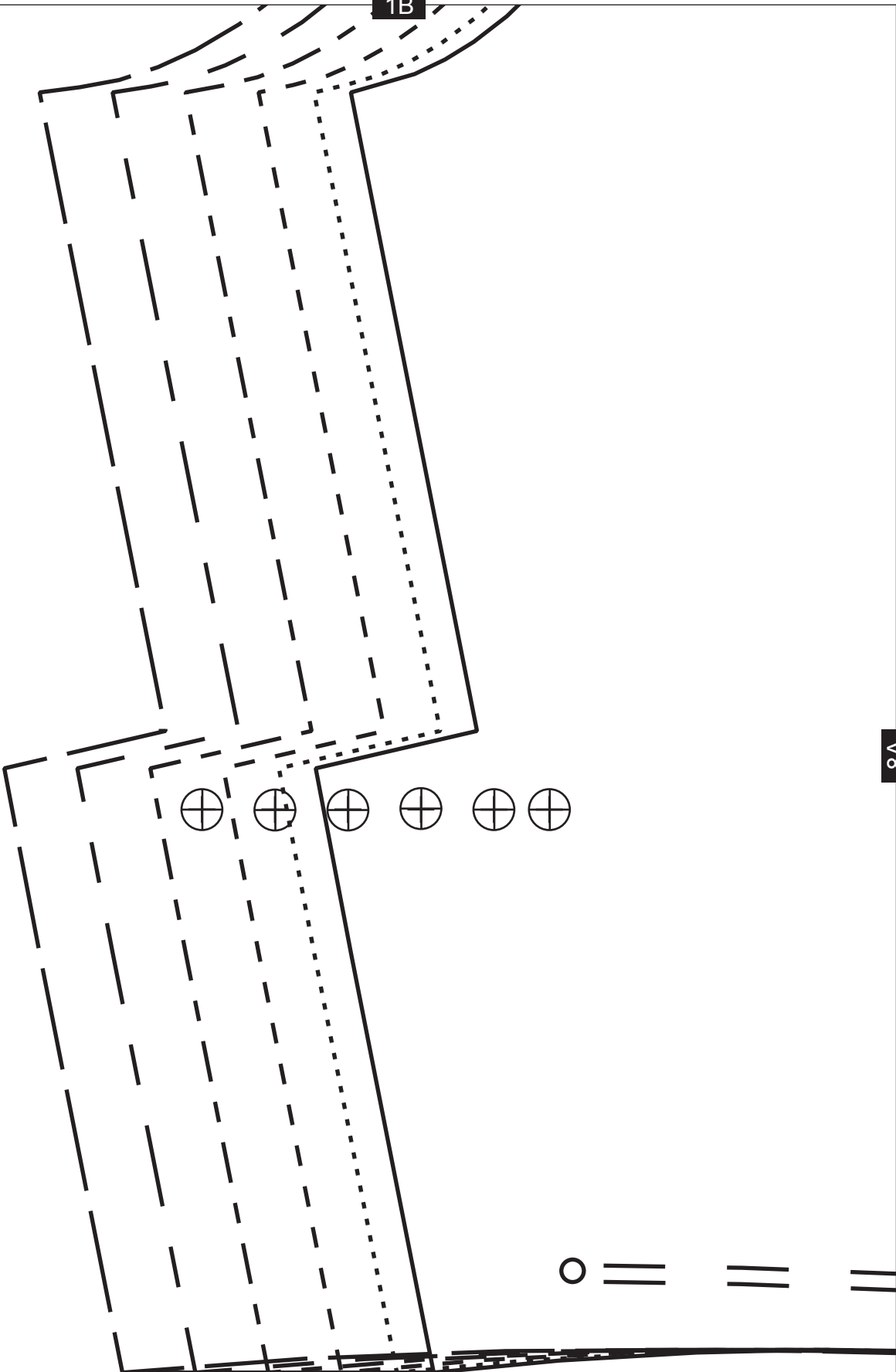

8A

8B

2B

PLACE ON FOLD



8A

9A



9B

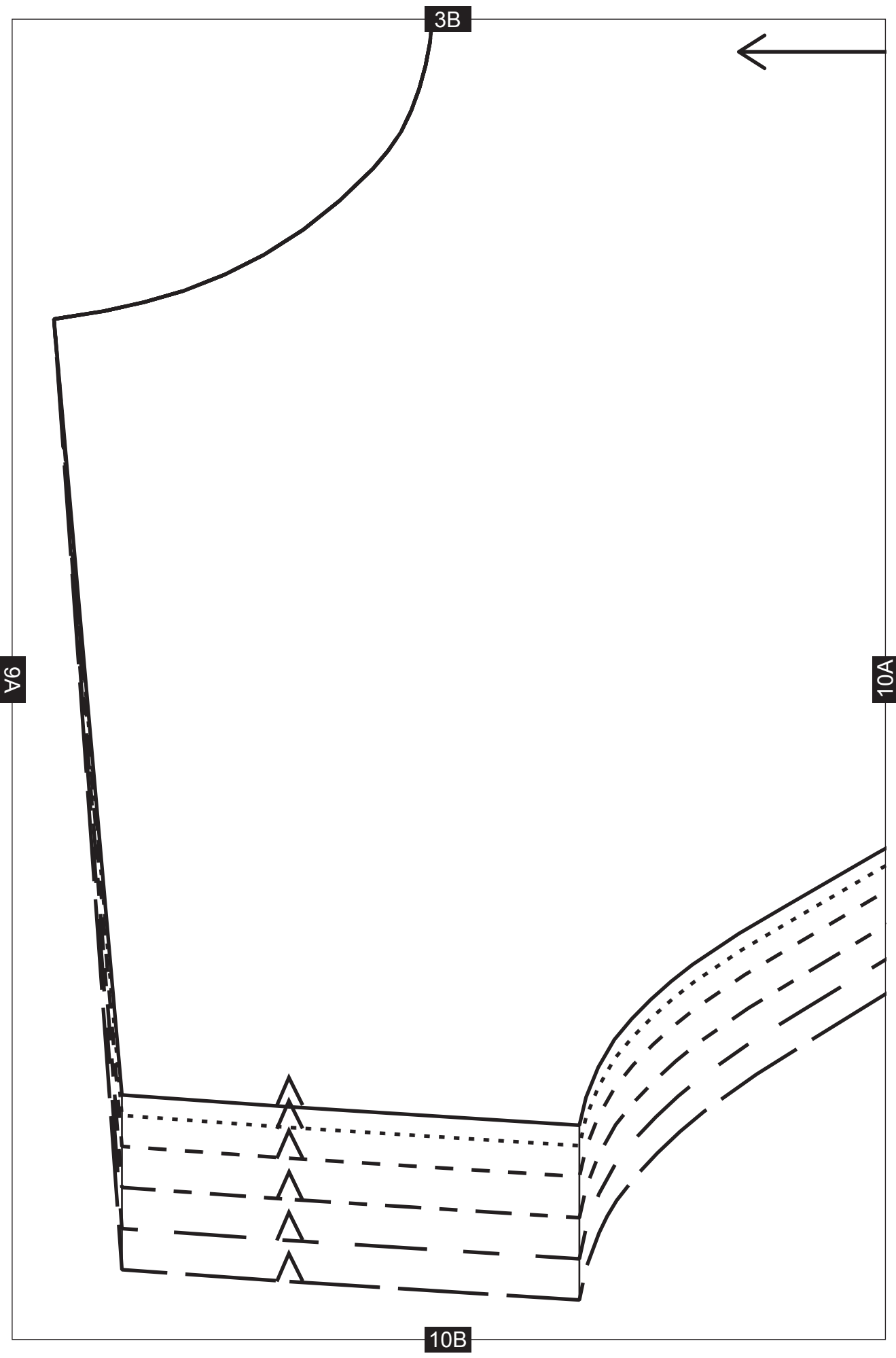

3B

9A

10A

10B

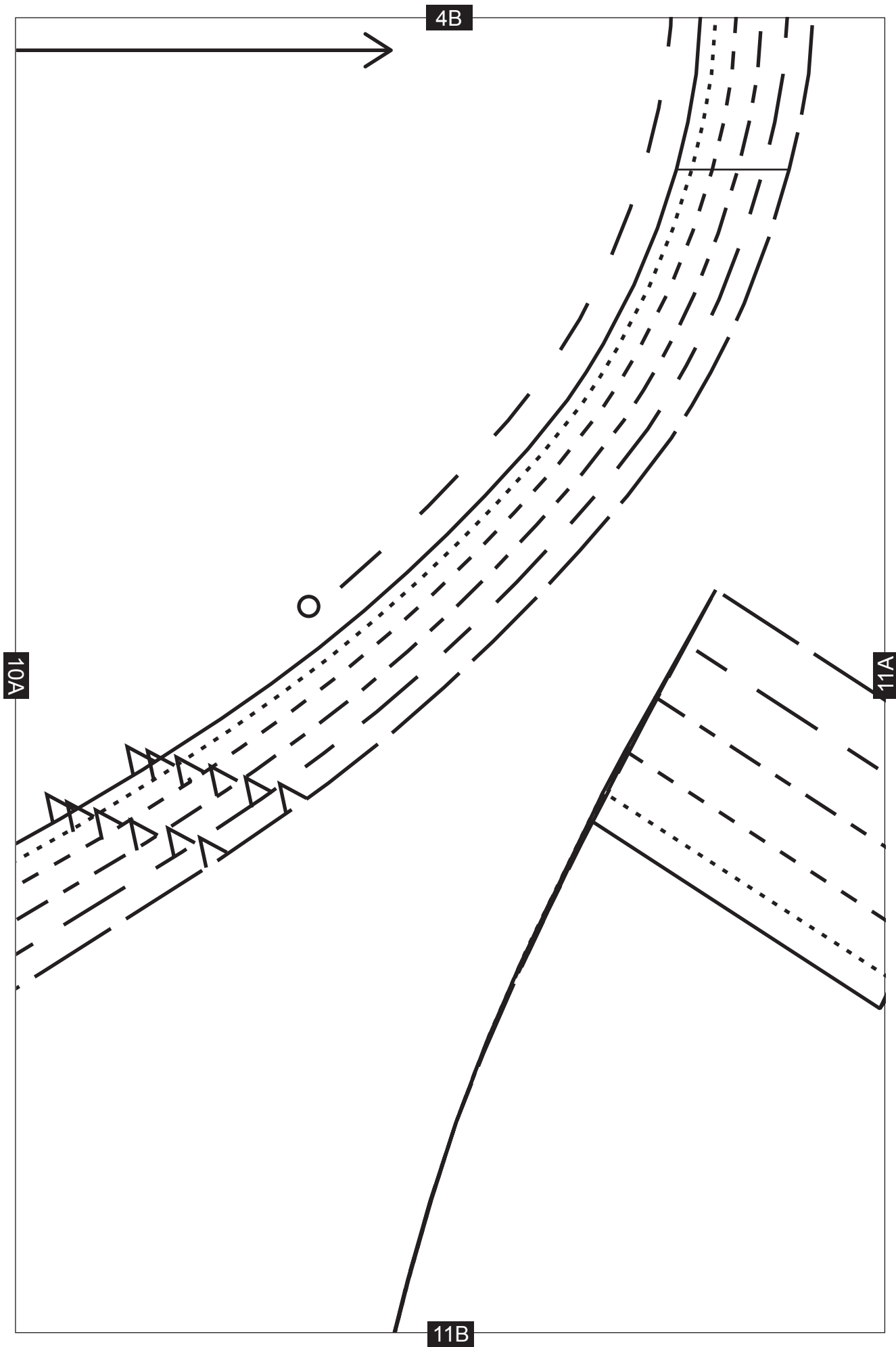

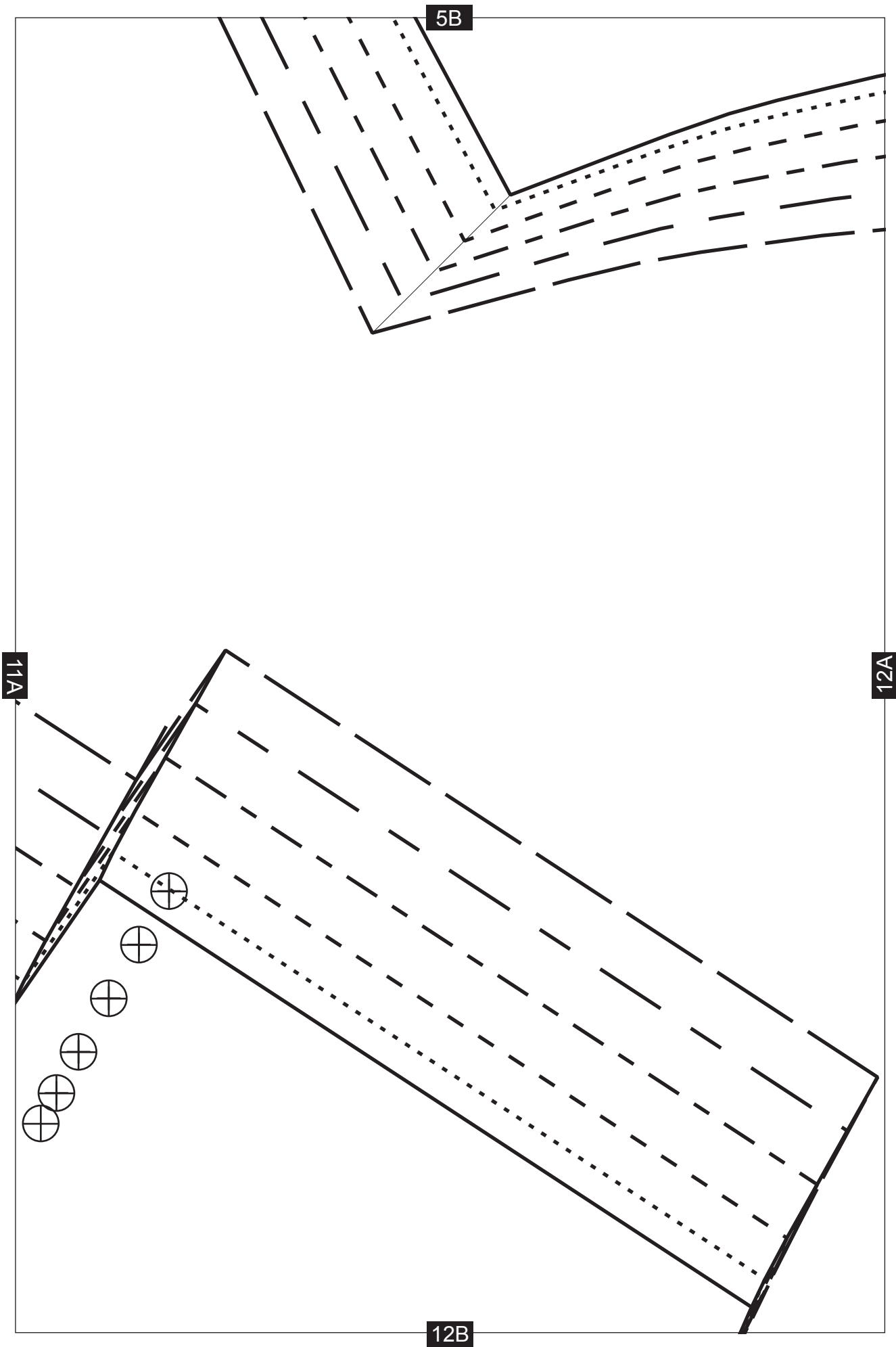

6B

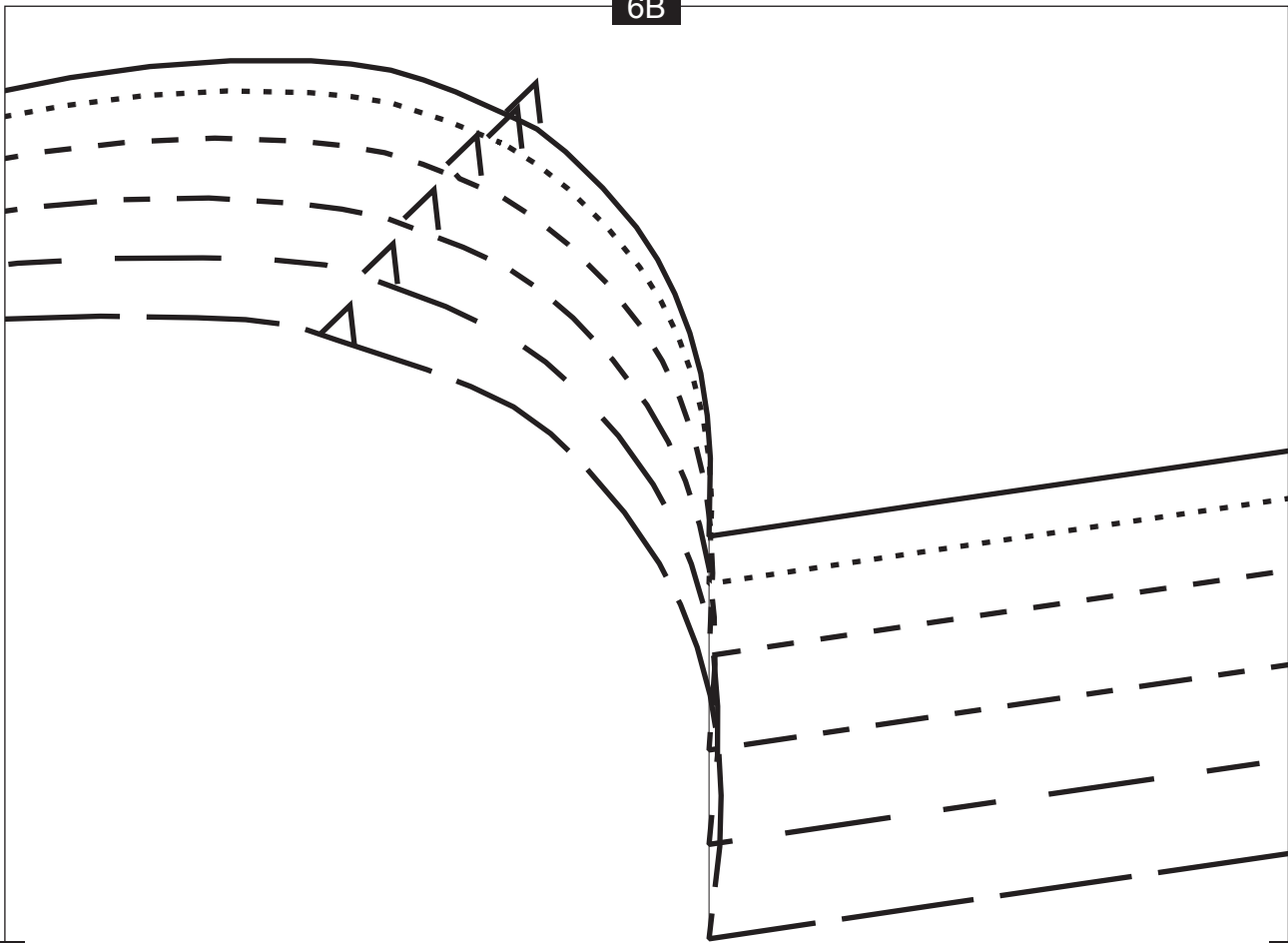

12A

13A

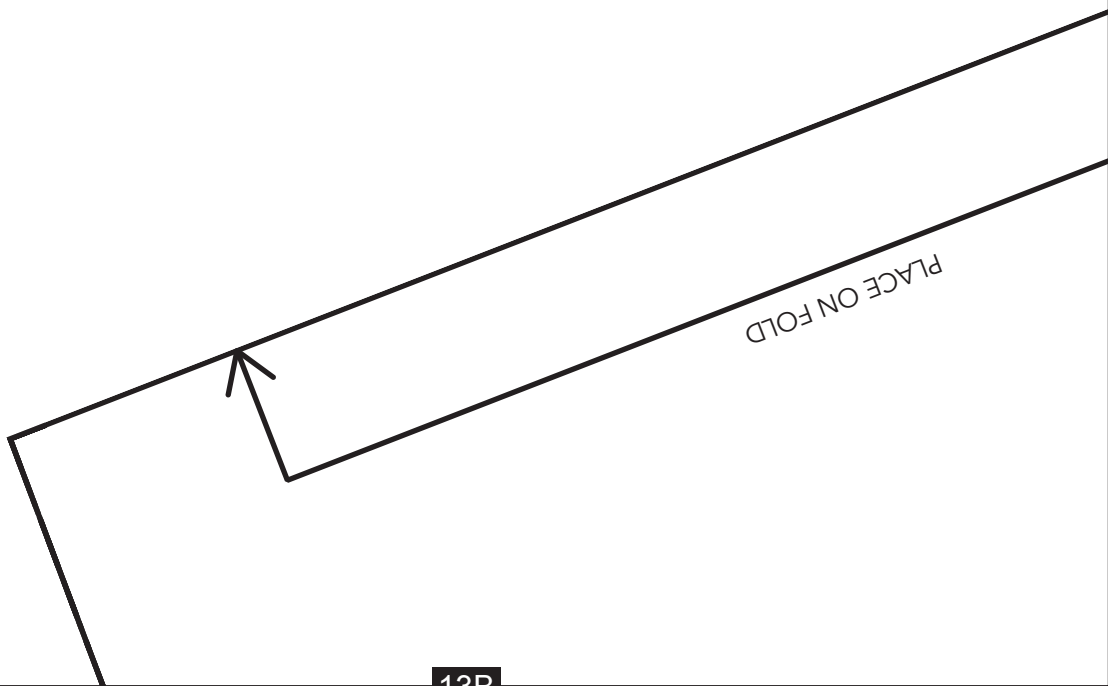

13B

7B

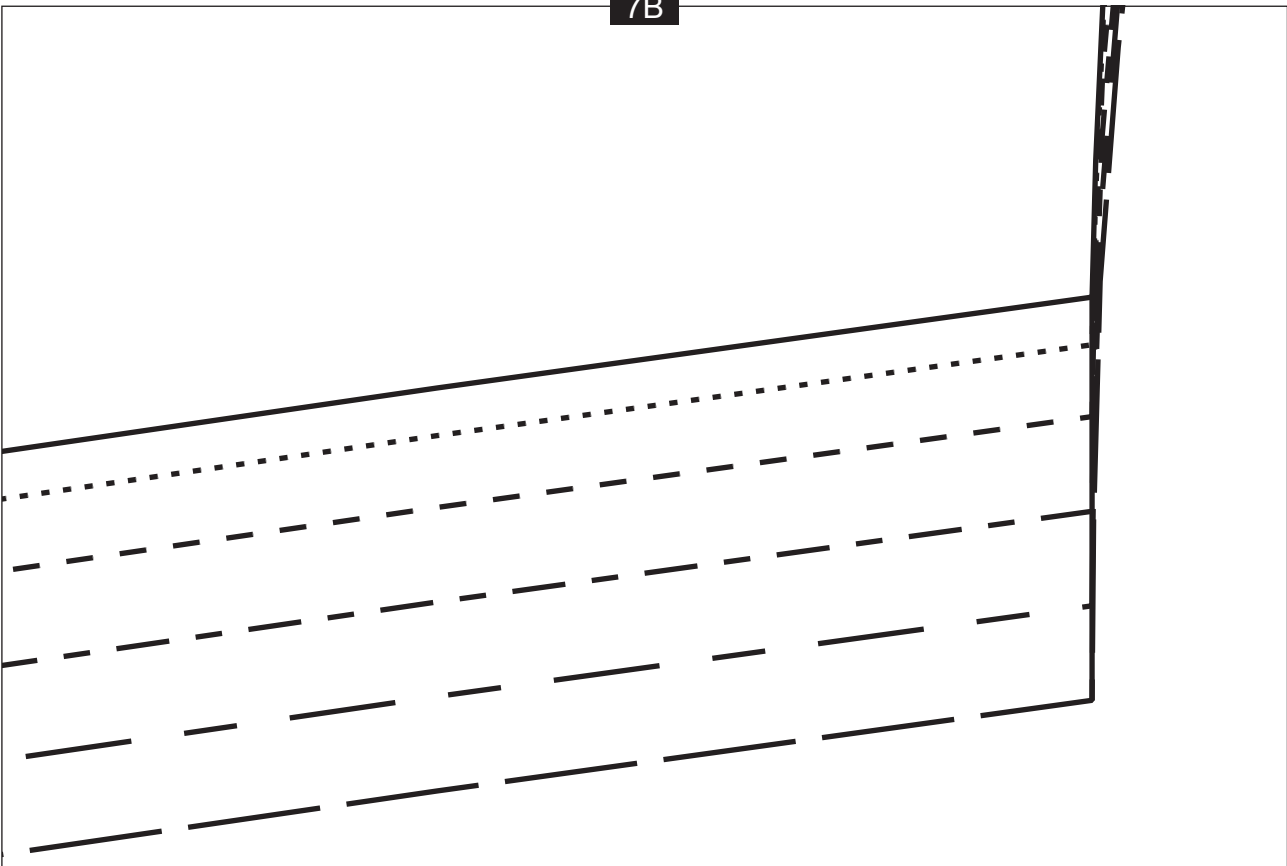

13A

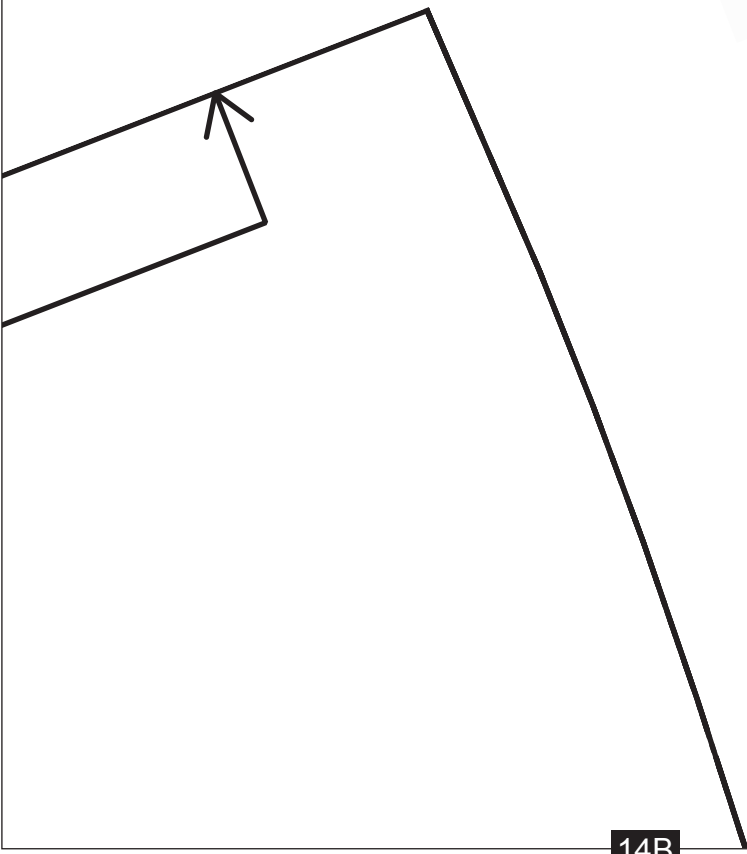

14B

BACK FACING

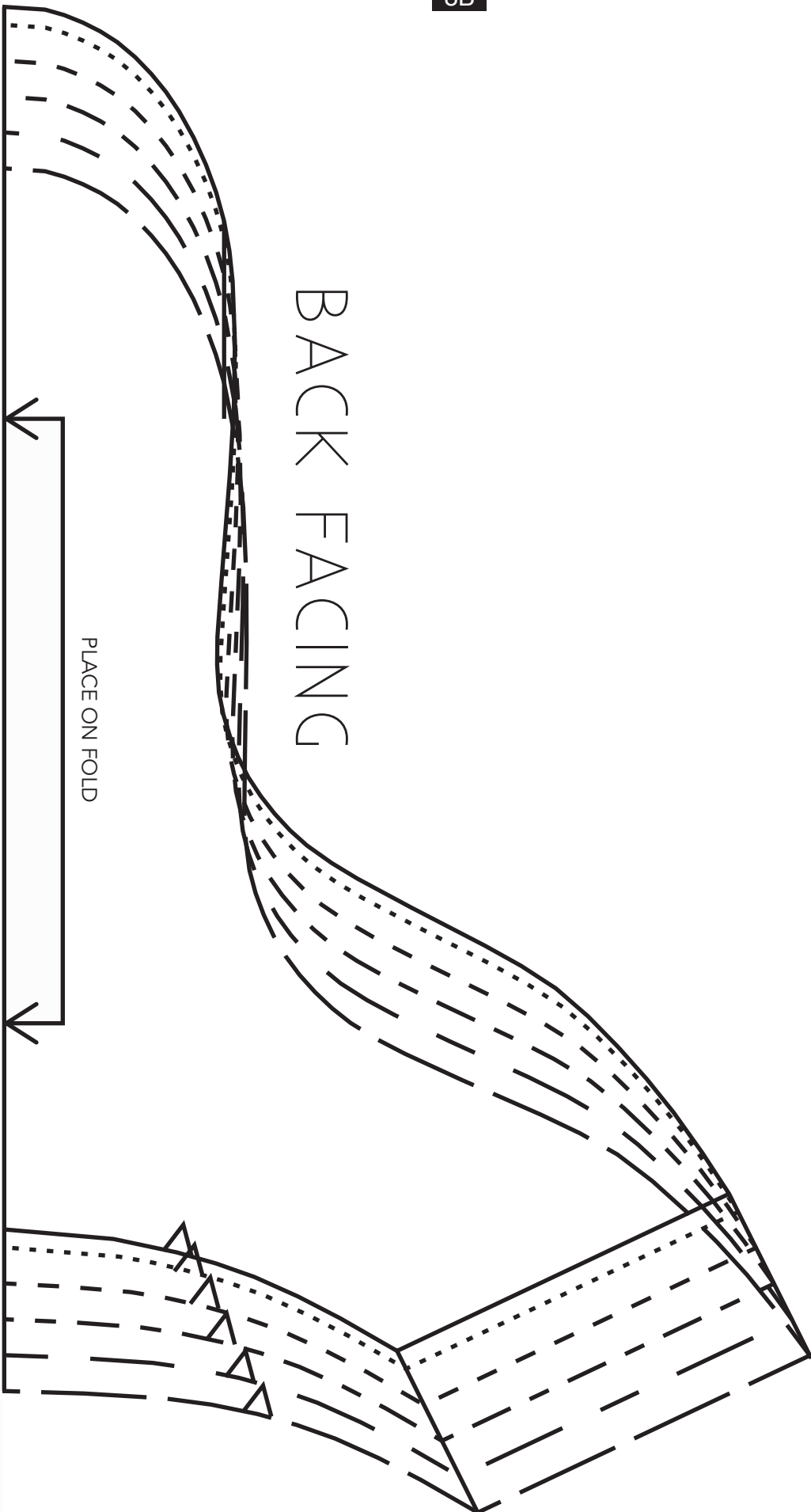

PLACE ON FOLD

9B

15A

16A

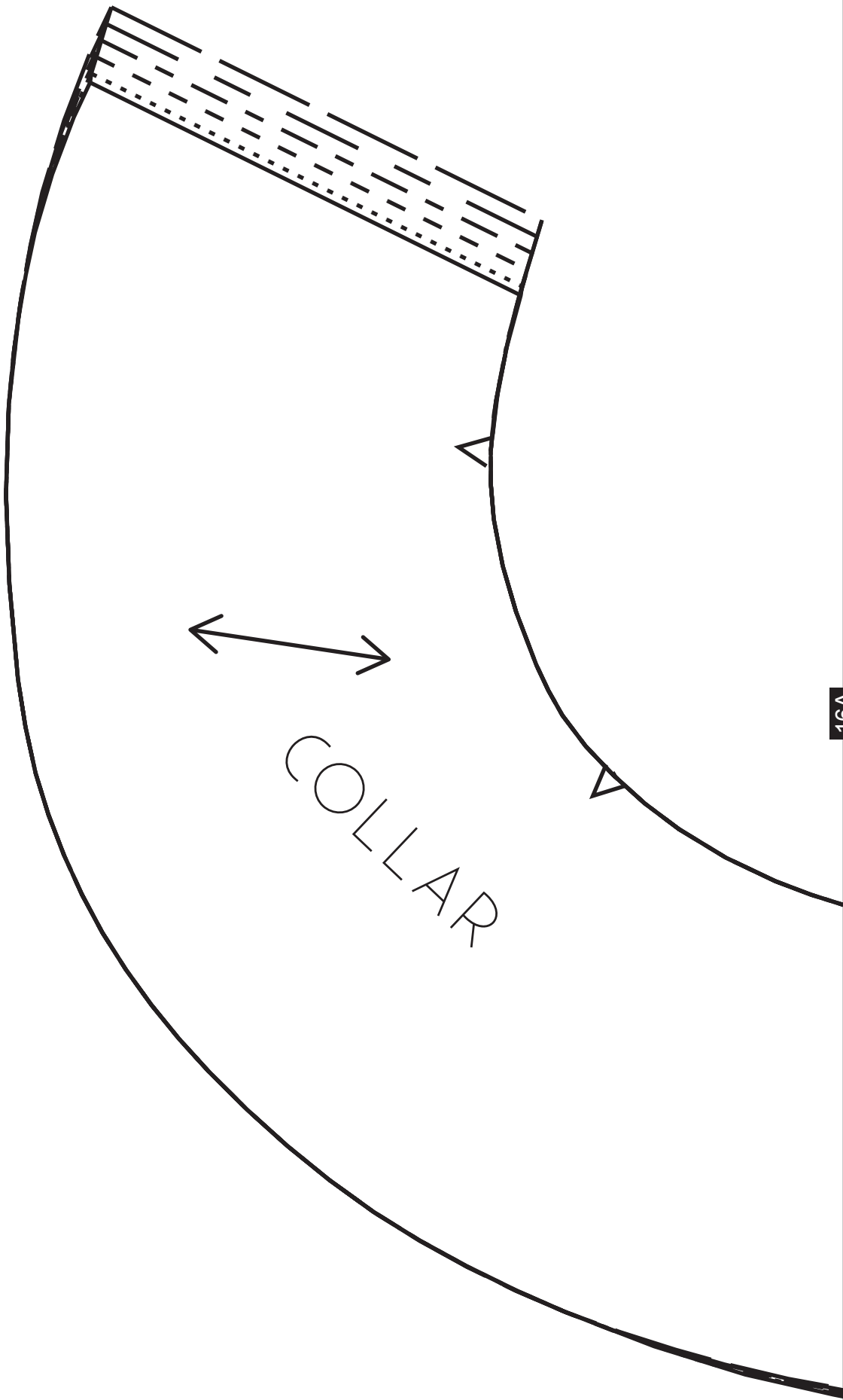

COLLAR

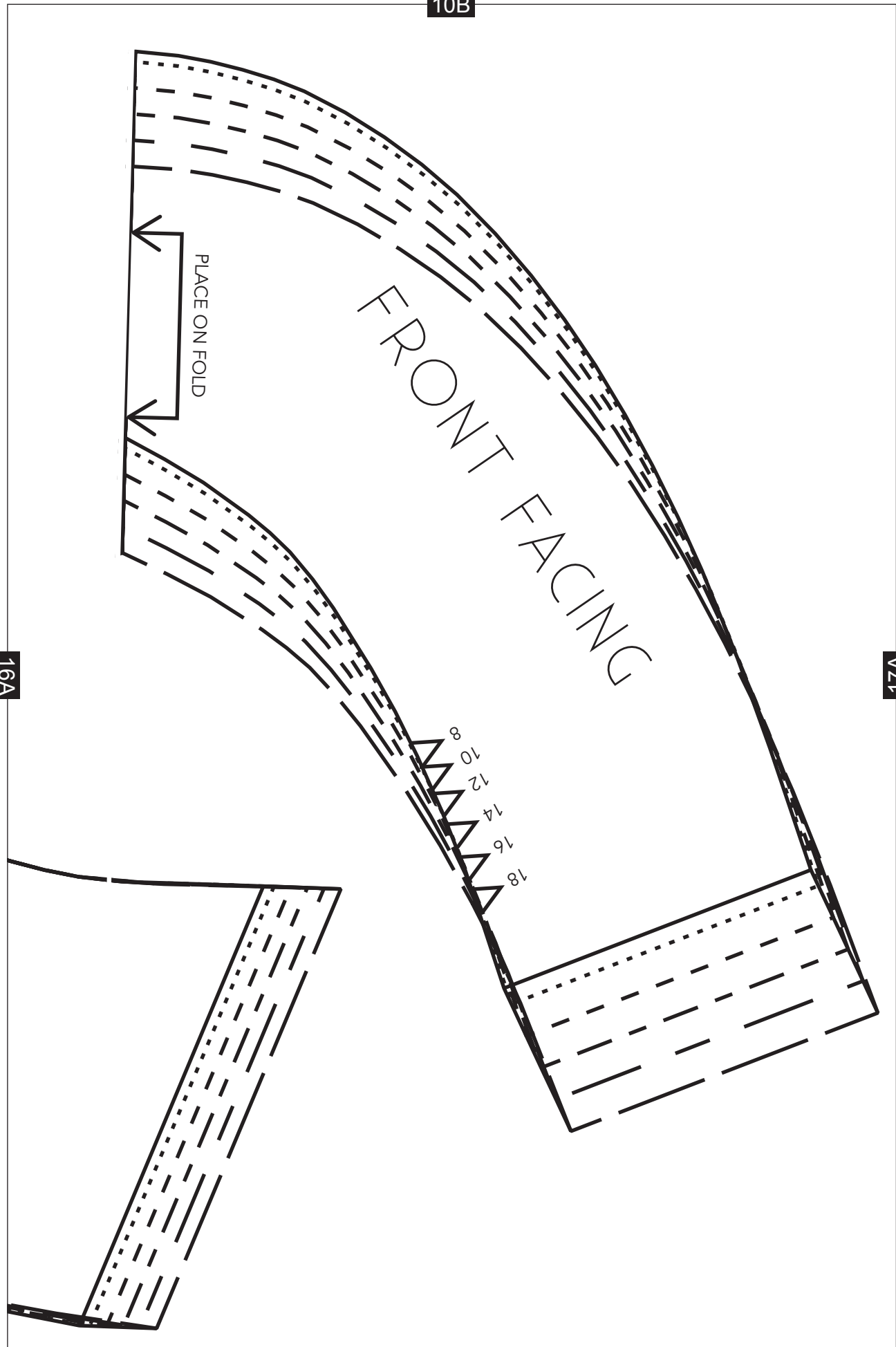

11B

BACK
PEPLUM

18A

PLACE ON FOLD



17A

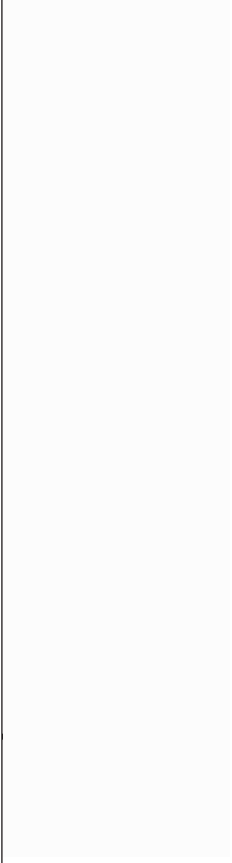

12B

18A

19A

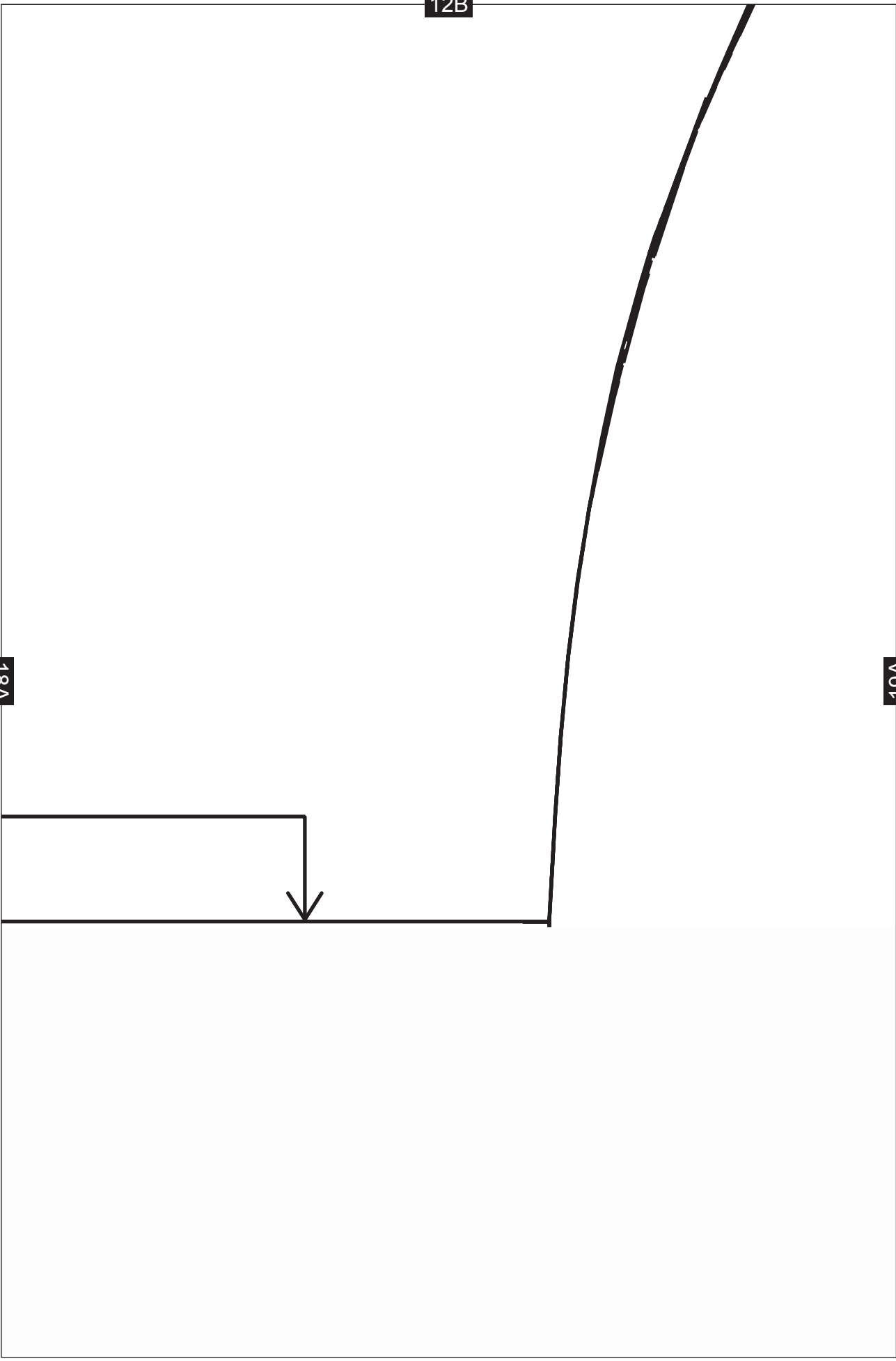

13B

19A

20A

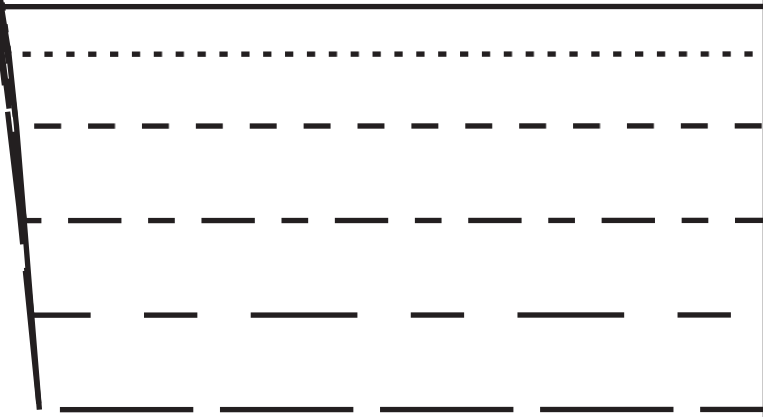
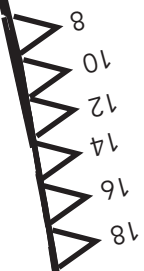

14B

FRONT PEPULUM

20A

